

TERMİKEL

product catalog



www.termikel.com.tr



TERMİKEL

Termikel A.Ş. has been maintaining the success story which started in 1950 with Termo Pressure Cooker based on the principle of Mr. Mehmet Kaya, the founder, who says: "The half of the success in business depends on courage and the other half on courtesy". Today the trademark "Termikel" is conveyed to the entire world out of the borders of Turkey with the free standing and built-in products offered by Termikel A.Ş.

Termikel is carrying out the production, sales and marketing organizations of the free standing and built-in oven and cookers through different companies of it, one of them being in Germany. Apart from its broad export network, it offers to the consumers a wide range of products with its Termikel built-in product concept

shops and showrooms. Since its foundation, Termikel has signed many innovations like the first rectangle oven with glass door, first mini-washing machine with automatic wringer and the first churn with eccentric belt and it has found its respectable place among the leading companies of the sector. As of 2008, the company keeps on its productions in one of the biggest and most modern facilities of Turkey and Europe. Termikel carries out its productions in its new facilities of 45.000 sqm which has been built on an open area of 60.000 sqm. The company manufactures all kinds of ovens, whether free standing or built-in, electricity or LPG or natural gas operated, with the Termikel assurance and at the international standards by expert teams in all stages from design to after sales services.

Built - in ovens

Page 3 - 16



Table top hobs

Page 47 - 50



Built-in hobs

Page 17 - 27



Midi ovens

Page 51 - 55



Hoods

Page 29 - 36



Aspirators

Page 57 - 58



Free standing cookers

Page 37 - 45



Washing machines

Page 59 - 60





built-in ovens



Energy Class A 11 Functions



BO 6361

- Full glass and touch control panel without any button
- 24 hour programmable multi color digital timer.
- Cooling fan helps to keep the control panel, knobs and kitchen furniture to stay cool.
- Grill function enables to have grilling all time - meat propafunction
- Oven inner lamp
- By thermostatic controls you can cook your meal to any desired temperature.
- 2 cooking enameled trays and 1 grill grid.
- Removable oven door for easy cleaning
- Telescopic rail is available upon request
- 58 liter inner cavity volume
- A Class Energy consumption

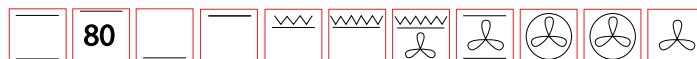



BO 6451

- 8 functions
- Full glass control panel with semi touch control digital timer.
- Cooling fan helps to keep the control panel, knobs and kitchen furniture to stay cool.
- Grill function enables to have grilling all time.
- Oven inner lamp
- By thermostatic controls you can cook your meal to any desired temperature.
- 2 cooking enameled trays and 1 grill grid.
- Removable oven door for easy cleaning
- Telescopic rail is available upon request
- Very elegant look with the Push-in Push-out knobs, easy to clean.
- 58 liter inner cavity volume
- A Class Energy consumption

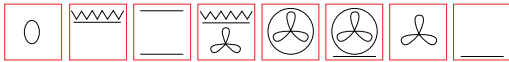

BO 6341

- 8 functions
- Side opening oven door
- 24 hour programmable multi color digital timer
- Cooling fan helps to keep the control panel, knobs and kitchen furniture to stay cool
- Grill function enables to have grilling all time
- Oven inner lamp
- By thermostatic controls you can cook your meal at any desired temperature.
- 2 cooking enameled trays and 1 grill tray
- Very elegant look with the Push-in - out knobs, easy to clean
- 58 lt inner cavity volume
- A class energy consumption

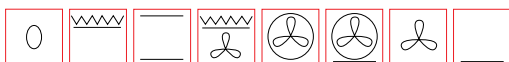

Energy Class A 8 Functions



BO 6352

- 8 functions
- Full glass control panel with semi touch control digital timer.
- 24 hour programmable multi color digital timer
- Cooling fan helps to keep the control panel, knobs and kitchen furniture to stay cool
- Grill function enables to have grilling all time
- Oven inner lamp
- By thermostatic controls you can cook your meal at any desired temperature.
- 2 cooking enameled trays and 1 grill tray
- Very elegant look with the Push-in - out knobs, easy to clean
- 58 lt inner cavity volume
- A class energy consumption

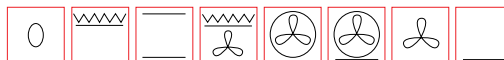

Energy Class A 8 Functions



BO 6500 Patterned Illumination

- 8 functions
- Decorative oven glass door
- Full glass oven door with push button control panel
- 24 hour programmable multi color digital timer
- Cooling fan helps to keep the control panel, knobs and kitchen furniture to stay cool
- Grill function enables to have grilling all time
- Oven inner rectangular lamp
- By thermostatic controls you can cook your meal at any desired temperature
- 2 cooking enameled trays and 1 grill grid
- Telescopic rail is available upon request
- 58 liter inner cavity volume
- A Class Energy consumption

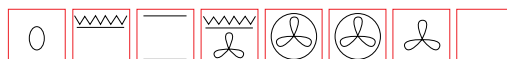

Energy Class A 8 Functions



BO 6500 Maiden's Tower

8 functions

- Decorative oven glass door
- Full glass oven door with push button control panel
- 24 hour programmable multi color digital timer
- Cooling fan helps to keep the control panel, knobs and kitchen furniture to stay cool
- Grill function enables to have grilling all time
- Oven inner lamp
- By thermostatic controls you can cook your meal at any desired temperature
- 2 cooking enameled trays and 1 grill grid
- Telescopic rail is available upon request
- 58 liter inner cavity volume
- A Class Energy consumption

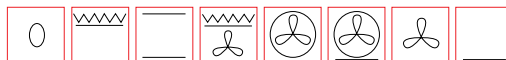

**Energy Class A
8 Functions****BO 6500 Sunflower**

8 functions

- Decorative oven glass door
- Full glass oven door with push button control panel
- 24 hour programmable multi color digital timer
- Cooling fan helps to keep the control panel, knobs and kitchen furniture to stay cool
- Grill function enables to have grilling all time
- Oven inner lamp
- By thermostatic controls you can cook your meal at any desired temperature
- 2 cooking enameled trays and 1 grill grid
- Telescopic rail is available upon request
- 58 liter inner cavity volume
- A Class Energy consumption

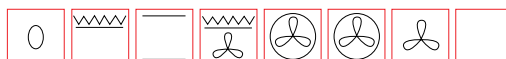

Energy Class A 9 Functions



BO 6030 Chef Cooker

- 9 functions
- 24 hour programmable multi color digital timer
- Cooling fan helps to keep the control panel, knobs and kitchen furniture to stay cool
- Grill function enables to have grilling all time
- Oven inner lamp
- By thermostatic controls you can cook your meal at any desired temperature.
- 2 cooking enameled trays and 1 grill tray
- 58 lt inner cavity volume
- A class energy consumption

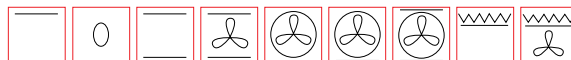



BO 6031 Chef Cooker

- 6 functions
- Mechanical minute minder 0-90 + cut off function
- Cooling fan helps to keep the control panel, knobs and kitchen furniture to stay cool
- Grill function enables to have grilling all time
- Oven inner lamp
- By thermostatic controls you can cook your meal at any desired temperature.
- 2 cooking enameled trays and 1 grill tray
- 58 lt inner cavity volume
- A class energy consumption



BO 6032 Chef Cooker

- 5 functions
- Cooling fan helps to keep the control panel, knobs and kitchen furniture to stay cool
- Grill function enables to have grilling all time
- Oven inner lamp
- By thermostatic controls you can cook your meal at any desired temperature.
- 2 cooking enameled trays and 1 grill tray
- 58 lt inner cavity volume
- A class energy consumption



Energy Class A 8 Functions



BO 6131

- 8 functions
- 24 hour programmable multi color digital timer.
- Cooling fan helps to keep the control panel, knobs and kitchen furniture to stay cool.
- Grill function enables to have grilling all time.
- Oven inner lamp
- By thermostatic controls you can cook your meal at any desired temperature.
- 2 cooking enameled trays and 1 grill grid.
- Very elegant look with the Push-in Push-out knobs, easy to clean.
- 58 liter inner cavity volume
- A Class Energy consumption

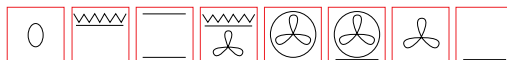

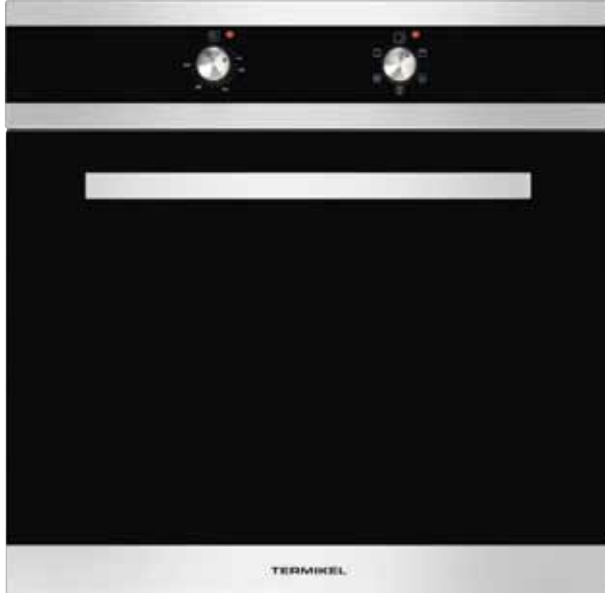

BO 6121

- 6 functions
- Cooling fan helps to keep the control panel, knobs and kitchen furniture to stay cool.
- Grill function enables to have grilling all time.
- Oven inner lamp
- By thermostatic controls you can cook your meal at any desired temperature.
- 2 cooking enameled trays and 1 grill grid.
- Very elegant look with the Push-in Push-out knobs, easy to clean.
- 58 liter inner cavity volume
- A Class Energy consumption

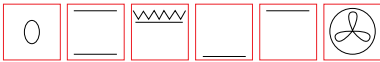

BO 6111

- 5 functions
- Mechanical minute minder 0-90 + cut off function
- Cooling fan helps to keep the control panel, knobs and kitchen furniture to stay cool.
- Grill function enables to have grilling all time.
- Oven inner lamp
- By thermostatic controls you can cook your meal at any desired temperature.
- 2 cooking enameled trays and 1 grill grid.
- Very elegant look with the Push-in Push-out knobs, easy to clean.
- 58 liter inner cavity volume
- A Class Energy consumption



Energy Class A 7 Functions



BO 6530

- 7 functions
- 24 hour programmable multi color digital timer.
- Cooling fan helps to keep the control panel, knobs and kitchen furniture to stay cool.
- Grill function enables to have grilling all time.
- Oven inner lamp
- By thermostatic controls you can cook your meal at any desired temperature.
- Long lasting shiny stainless steel control panel.
- 2 cooking enameled trays and 1 grill grid.
- Very elegant look with the Push-in Push-out knobs, easy to clean.
- 58 liter inner cavity volume
- A Class Energy consumption





BO 6531

- 7 functions
- Mechanical minute minder 0-90 + cut off function
- Cooling fan helps to keep the control panel, knobs and kitchen furniture to stay cool.
- Grill function enables to have grilling all time.
- Oven inner lamp
- By thermostatic controls you can cook your meal at any desired temperature.
- Long lasting shinny stainless steel control panel.
- 2 cooking enameled trays and 1 grill grid.
- Very elegant look with the Push-in Push-out knobs, easy to clean.
- 58 liter inner cavity volume
- A Class Energy consumption



BO 6532

- 5 functions
- Cooling fan helps to keep the control panel, knobs and kitchen furniture to stay cool
- Grill function enables to have grilling all time
- Oven inner lamp
- By thermostatic controls you can cook your meal at any desired temperature.
- Long lasting shinny stainless steel control panel
- 2 cooking enameled trays and 1 grill tray
- Very elegant look with the Push-in - out knobs, easy to clean
- 58 lt inner cavity volume
- A class energy consumption





BO 6556

- 7 functions
- Colour illuminated control panel
- Cooling fan helps to keep the control panel, knobs and kitchen furniture to stay cool
- Grill function enables to have grilling all time
- Oven inner rectangular lamp
- By thermostatic controls you can cook your meal at any desired temperature
- 2 cooking enameled trays and 1 grill grid
- Telescopic ray is available upon request
- 58 liter inner cavity volume
- A Class Energy consumption



AG 925 BFY

- Built in Microwave oven
- Microwave: 900 W
- Grill: 1000W
- LED timer display
- Functions: defrosting, cooking, combi-cooking, quick start
- Safety lock for children
- Stainless steel inner cavity
- Oven inner lamp
- Rotating glass plate
- 1 grill wire

Technical Properties

- Electric power: 2.3kW
- Appliance Dimensions (WxHxD): 592 x 370 x 330 mm
- Cooking zone dimensions (WxHxD): 282 x 205 x 285 mm
- Installation dimensions: (WxHxD): 594 x 400 x 460 mm

built-in hobs



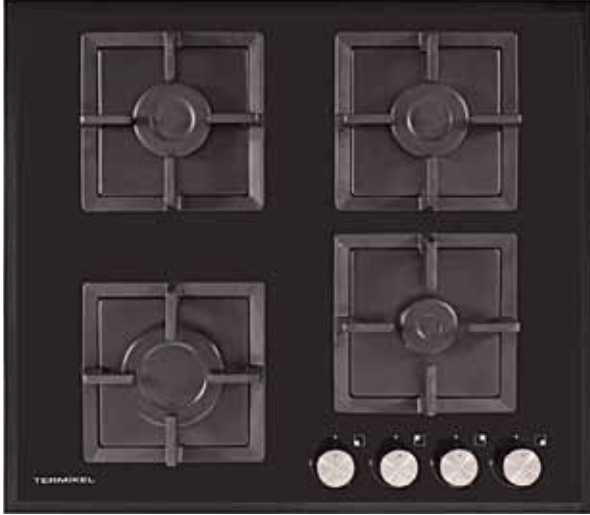

17251 B604 - D/L

- Front mounted control knobs
- 4 gas burners with automatic ignition system
- Secure glass surface, easy to clean
- Automatic gas safety system
- Cast iron pan supports
- 1 strong burner: 3000W
- 2 normal burner: 1750W
- 1 economic burner: 1000W



17252 B604 - D/L

- Side mounted control knobs
- 4 gas burners with automatic ignition system
- Secure glass surface, easy to clean
- Cast iron pan supports
- 1 strong burner: 3000W
- 2 normal burner: 1750W
- 1 economic burner: 1000W

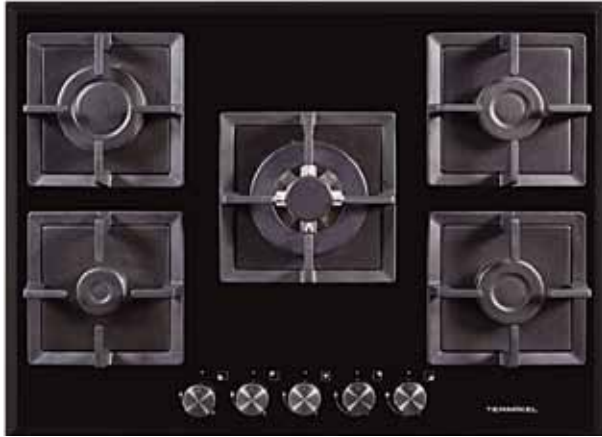

17255 B705W2D

- 70 cm built-in glass hob
- Front mounted control knobs
- 5 gas burners with automatic ignition system
- Secure glass surface, easy to clean
- Automatic gas safety system
- Cast iron pan supports
- 1 strong burner: 3000W
- 2 normal burners: 1750W
- 1 economic burner: 1000W
- 1 triple wok burner: 3500W



17256 B302 - D/L

- 30 cm domino vitro ceramic glass gas hob
- Cast iron pan supports
- Auto ignition system
- Secure glass surface, easy to clean
- 1 strong burner: 3000W
- 1 normal burners: 1750W



17257 B301W2 - D/L

- 30 cm domino vitro ceramic glass gas hob
- Cast iron pan supports
- Auto ignition system
- Secure glass surface, easy to clean
- 1 strong wok burner: 3600W

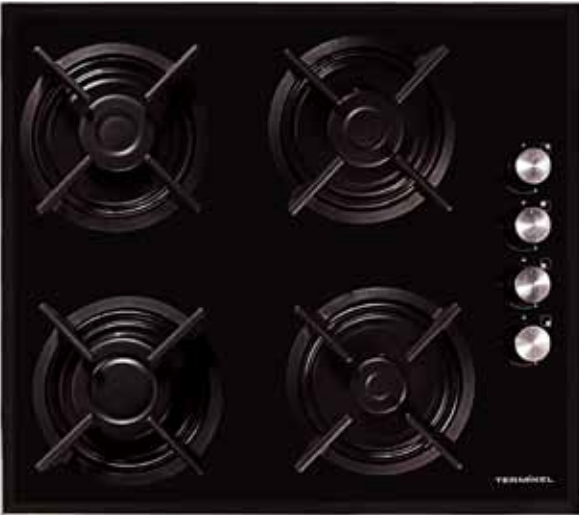

17152 B604 - D/L

- 60 cm., glass built-in hob
- High quality stainless steel full frame
- Side mounted control knobs
- 4 gas burners with automatic ignition system
- Secure glass surface, easy to clean
- 1 strong burner: 3000W
- 2 normal burner: 1750W
- 1 economic burner: 1000W

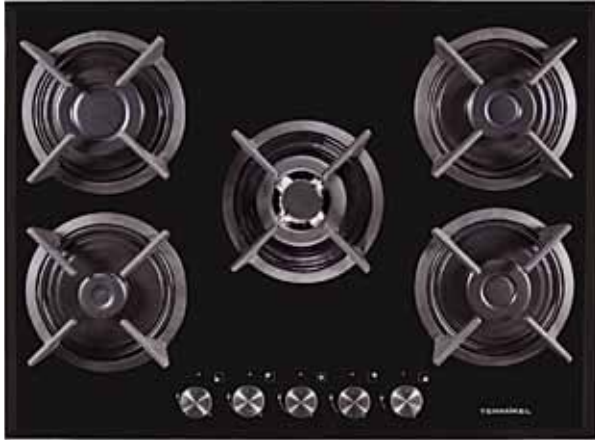

17155 B705W1 - D/L

- 70 cm built-in glass hob
- Front mounted control knobs
- 5 gas burners with automatic ignition system
- Secure glass surface, easy to clean
- Automatic gas safety system
- Cast iron pan supports
- 1 strong burner: 3000W
- 2 normal burners: 1750W
- 1 economic burner: 1000W
- 1 triple wok burner: 3500W

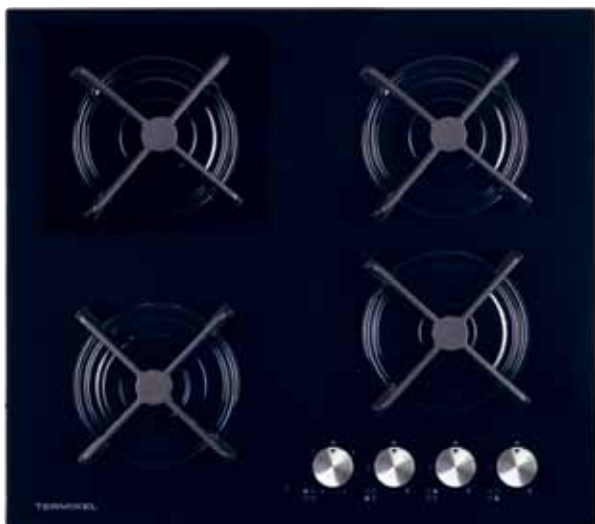

17151 B604 - D/L

- Front mounted control knobs
- 4 gas burners with automatic ignition system
- Secure glass surface, easy to clean
- Automatic gas safety system
- Cast iron pan supports
- 1 strong burner: 3000W
- 2 normal burner: 1750W
- 1 economic burner: 1000W



17051 W604 - D/L

- Front mounted control knobs
- 4 gas burners with automatic ignition system
- Secure glass surface, easy to clean
- Automatic gas safety system
- Cast iron pan supports
- 1 strong burner: 3000W
- 2 normal burner: 1750W
- 1 economic burner: 1000W



17052 W604 - D/L

- Side mounted control knobs
- 4 gas burners with automatic ignition system
- Secure glass surface, easy to clean
- Cast iron pan supports
- 1 strong burner: 3000W
- 2 normal burner: 1750W
- 1 economic burner: 1000W

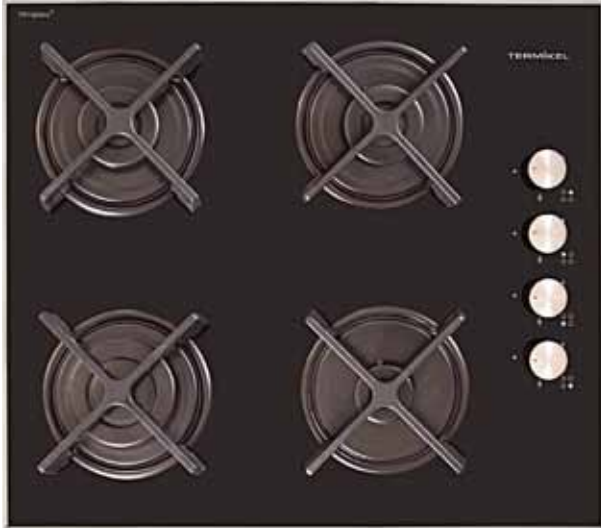

17052 B604 - D/L

- Side mounted control knobs
- 4 gas burners with automatic ignition system
- Secure glass surface, easy to clean
- Cast iron pan supports
- 1 strong burner: 3000W
- 2 normal burner: 1750W
- 1 economic burner: 1000W

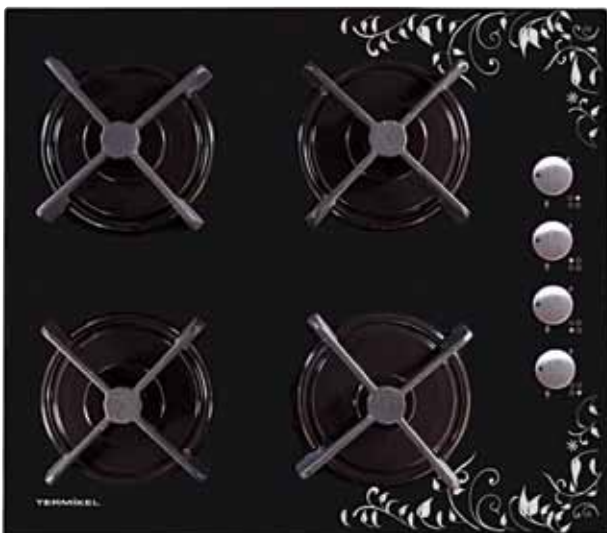

17052 B604 - D/L Patterned Illumination

- Side mounted control knobs
- 4 gas burners with automatic ignition system
- Secure glass surface, easy to clean
- Cast iron pan supports
- 1 strong burner: 3000W
- 2 normal burner: 1750W
- 1 economic burner: 1000W

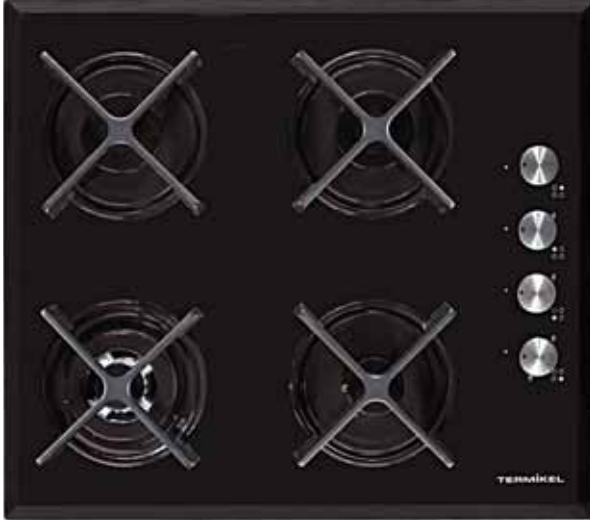

17052 B604W1 - D/L

- Side mounted control knobs
- 4 gas burners with automatic ignition system
- Secure glass surface, easy to clean
- Cast iron pan supports
- 1 strong burner: 3000W
- 2 normal burner: 1750W
- 1 economic burner: 1000W
- Optional wok burner



17055 B705W1XK - D/L

- 70 cm built-in glass hob
- High quality stainless steel full frame
- Front mounted control knobs
- 5 gas burners with automatic ignition system
- Secure glass surface, easy to clean
- Automatic gas safety system
- 1 strong burner: 3000W
- 2 normal burners: 1750W
- 1 economic burner: 1000W
- 1 triple wok burner: 3500W

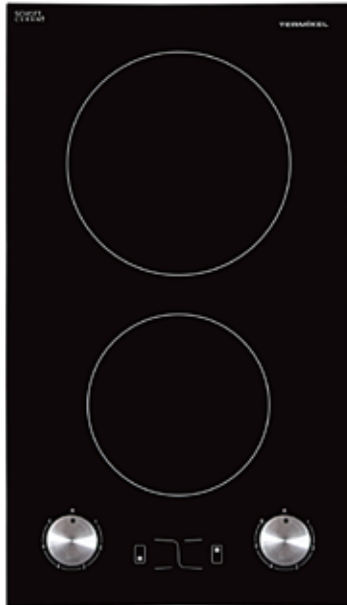

17076 B302 D

- 30 cm domino vitro ceramic glass electric hob
- High quality stainless steel frame
- Secure glass surface, easy to clean
- 1 Hilight - cooking zone: 140 Ø
- 1 Hilight - cooking zone: 180 Ø



17056 B302 - D/L

- 30 cm domino vitro ceramic glass gas hob
- Cast iron pan supports
- Auto ignition system
- Secure glass surface, easy to clean
- 1 strong burner: 3000W
- 1 normal burners: 1750W

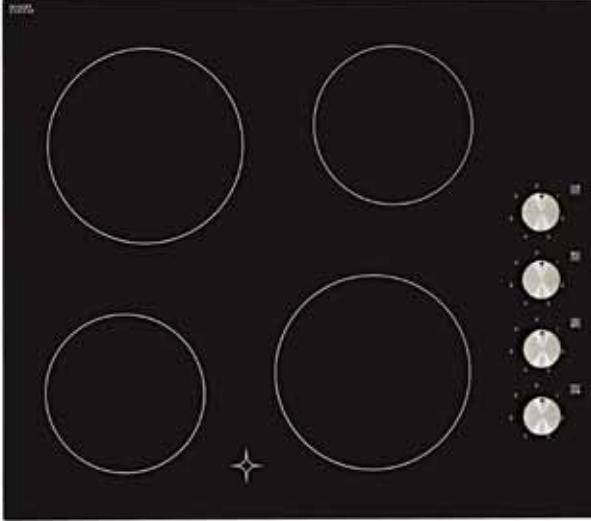

17075 B604

- 60 cm vitro ceramic built-in hob
- 2 hilight cooking zone: Ø 180mm / 1800 W
- 2 hilight cooking zone: Ø 145mm / 1200 W
- Side mounted ergonomic control panel
- Total power: 6.0 kW

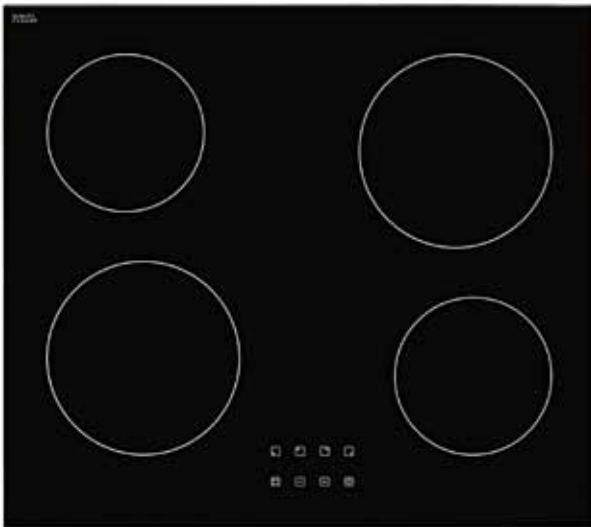

17090 B604 D touch

- Slim line high quality stainless steel
- Touch control use
- Programmable timer
- Automatic safety switch off
- Safety lock for child use
- Automatic heating
- 4 quick-lite cooking zones
- 2 Hilight - cooking zone Ø 180 mm/ 1800 W
- 2 Hilight - cooking zone Ø 145 mm / 1200 W
- Power: 6.0 kW



17036 X604L

- Stainless steel surface
- Side mounted control knobs
- Auto ignition system
- Enameled pan supports, easy to clean
- 1 strong burner: 3000W
- 2 normal burners: 1750W
- 1 economic burner: 1000W



17046 X604L

- 3 gas + 1 electric
- Stainless steel surface
- Side mounted control knobs
- Auto ignition system
- Enameled pan supports, easy to clean
- 1 strong burner: 3000W
- 1 normal burners: 1750W
- 1 economic burner: 1000W
- 1 electric hot plate: 1000W



hoods





6035 Patterned Illumination

- Full black glass design with square form
- 5 different speed settings
- Touch button control system with remote control option
- Halogen bulb 2x20W / 12 V
- Timer function
- Filter cleaning warning function
- Turbo function
- Washable aluminum filter
- 2 optional active carbon filters for chimney free usage
- 120/150mm chimney output
- 600 m³/h exhaust capacity
- Noise level at step 1: 50db (A)
- Electric power: 290W



6035 - 60 cm / 90 cm

- Full black glass design with square form
- 5 different speed settings
- Touch button control system with remote control option
- Halogen bulb 2x20W / 12 V
- Timer function
- Filter cleaning warning function
- Turbo function
- Washable aluminum filter
- 2 optional active carbon filters for chimney free usage
- 120/150mm chimney output
- 600 m³/h exhaust capacity
- Noise level at step 1: 50db (A)
- Electric power: 290W



6040

- Full white glass design with square form
- 5 different speed settings
- Touch button control system with remote control option
- Halogen bulb 2x20W / 12 V
- Timer function
- Filter cleaning warning function
- Turbo function
- Washable aluminum filter
- 2 optional active carbon filters for chimney free usage
- 120/150mm chimney output
- 600 m³/h exhaust capacity
- Noise level at step 1: 50db (A)
- Electric power: 290W



5100

- 3 different speed settings
- Full glass design with square form
- Touch button control system with remote control option
- Halogen bulb 2x25W
- Washable aluminum filter
- 650 - 850 m³/h optional flow capacity
- Noise level at step 1: 50db (A)
- Electric power: 240W



5101

- 3 different speed settings
- Full glass design with circular form
- Touch button control system with remote control option
- Halogen bulb 2x25W
- Washable aluminum filter
- 650 - 850 m³/h optional flow capacity
- Noise level at step 1: 50db (A)
- Electric power: 240W



4104

- 3 different speed setting
- Digital button control system
- Halogen bulb 2X25 W
- Timer function
- Remote control option
- Aluminum filter
- 120mm chimney output
- 650 m³/h exhaust capacity
- Noise level at step 1:53 db(A)
- Electric power: 250 W



4101

- Stainless steel island hood,
- 7 different speed settings
- Halogen multi color control system
- Halogen bulb 4x20W
- Optional carbon filter for chimney free usage
- 800 m³/h optional air flow capacity
- Noise level at step 1: 45 db (A)
- Electric power: 290 W



4508 - 60 cm

- 3 different speed setting
- Touch button control system and remote control option
- Halogen bulb 2x25 W
- Washable aluminum filter
- 650-850 m³/h exhaust capacity
- Noise level at step 1:50 db(A)
- Electric power: 240 W



4408 - 60 cm / 90 cm

- 3 different speed setting
- Touch button control system and remote control option
- Halogen bulb 2x25 W
- Washable aluminum filter
- 650-850 m3/h exhaust capacity
- Noise level at step 1:50 db(A)
- Electric power: 240 W



4308 - 60 cm

- 3 different speed setting
- Touch button control system and remote control option
- Halogen bulb 2x25 W
- Washable aluminum filter
- 650-850 m3/h exhaust capacity
- Noise level at step 1:50 db(A)
- Electric power: 240 W



3500 - 60 cm

- White chimney hood
- Mechanical push button control system
- 3 different speed settings
- Halogen bulb 2x40W
- Washable aluminum filter
- 2 optional active carbon filters for chimney free usage
- 120/150mm chimney output
- 480 m³/h exhaust capacity
- Noise level at step 1: 50db (A)
- Electric power: 290W



3400 - 60 cm / 90 cm

- Stainless steel chimney hood
- Mechanical push button control system
- 3 different speed settings
- Halogen bulb 2x40W
- Washable aluminum filter
- 2 optional active carbon filters for chimney free usage
- 120/150mm chimney output
- 480 m³/h exhaust capacity
- Noise level at step 1: 50db (A)
- Electric power: 290W



3300 - 60 cm

- Black chimney hood
- Mechanical push button control system
- 3 different speed settings
- Halogen bulb 2x40W
- Washable aluminum filter
- 2 optional active carbon filters for chimney free usage
- 120/150mm chimney output
- 480 m³/h exhaust capacity
- Noise level at step 1: 50db (A)
- Electric power: 290W



3109 - 60 cm / 90 cm

- Secure and aesthetic design, easy to clean
- 3 speed and time control settings
- Decorative LED display with micro switch control system
- Remote control system
- Halogen bulb 2 x 20 W
- Optional carbon filter for chimney free usage
- 550 m³/h air flow capacity
- 800 m³/h optional air flow capacity
- Noise level at 1: 45 db (A)
- 1 fan motor 250 W

free standing cookers





13100 WMZS

- 7 functions
- White 60x60x86
- 4 gas burners with FFD, adjustable to natural gas
- Mechanical timer
- Locked gas switches and knobs
- Automatic ignition from the knobs
- Grill function
- Oven inner lamp
- Thermostat controls enables to cook at desired heat
- Effective cooking with equal heat circulation
- Protective glass lid
- 2 trays and 1 grill tray
- Utility drawer
- 58 lt inner cavity
- A class energy



13100 WDZS

- 7 functions
- White 60x60x86
- 4 gas burners with FFD, adjustable to natural gas
- 24 hour programmable digital timer
- Locked gas switches and knobs
- Automatic ignition from the knobs
- Grill function
- Oven inner lamp
- Thermostat controls enables to cook at desired heat
- Effective cooking with equal heat circulation
- Protective glass lid
- 2 trays and 1 grill tray
- Utility drawer
- 58 lt inner cavity
- A class energy



13100 IX DZS

- 7 functions
- Inox 60x60x86
- 4 gas burners with FFD, adjustable to natural gas
- 24 hour programmable digital timer
- Locked gas switches and knobs
- Automatic ignition from the knobs
- Grill function
- Oven inner lamp
- Thermostat controls enables to cook at desired heat
- Effective cooking with equal heat circulation
- Elegant inox design and protective glass lid
- 2 trays and 1 grill tray
- Utility drawer
- 58 lt inner cavity
- A class energy



13100 TIX DZS

- 7 functions
- Inox 60x60x86
- 4 gas burners with FFD, adjustable to natural gas
- 24 hour programmable digital timer
- 1 triple wok burner
- Locked gas switches and knobs
- Automatic ignition from the knobs
- Grill function
- Oven inner lamp
- Thermostat controls enables to cook at desired heat
- Effective cooking with equal heat circulation
- Elegant inox design and protective glass lid
- 2 trays and 1 grill tray
- Utility drawer
- 58 lt inner cavity
- A class energy



13110 WMZS

- 7 functions
- White 60x60x86
- 4 gas burners with FFD, adjustable to natural gas
- Static upper cavity and bottom cavity with turbo function
- Mechanical timer
- 2 cavities with same time function
- Locked gas switches and knobs
- Ignition from the knob
- Grill function
- Oven inner lamp
- Thermostat controls enables to cook at desired heat
- Effective cooking with equal heat circulation
- Protective glass lid
- 2 trays and 1 grill tray
- Utility drawer
- 58 lt bottom cavity, 27 lt upper cavity
- A class energy



13110 WDZS

- 7 functions
- White 60x60x86
- 4 gas burners with FFD, adjustable to natural gas
- Static upper cavity and bottom cavity with turbo function
- 24 hour programmable digital timer
- 2 cavities with same time function
- Locked gas switches and knobs
- Automatic ignition from the knobs
- Grill function
- Oven inner lamp
- Thermostat controls enables to cook at desired heat
- Effective cooking with equal heat circulation
- Protective glass lid
- 2 trays and 1 grill tray
- Utility drawer
- 58 lt bottom cavity, 27 lt upper cavity
- A class energy



13110 IX DZS

- 7 functions
- Inox 60x60x86
- 4 gas burners with FFD, adjustable to natural gas
- 24 hour programmable digital timer
- 2 cavities with same time function
- Static upper cavity and bottom cavity with turbo function
- Locked gas switches and knobs
- Automatic ignition from the knobs
- Grill function
- Oven inner lamp
- Thermostat controls enables to cook at desired heat
- Effective cooking with equal heat circulation
- Elegant inox design and protective glass lid
- 2 trays and 1 grill tray
- Utility drawer
- 58 lt bottom cavity, 27 lt upper cavity
- A class energy



13110 TIX DZS

- 7 functions
- Inox 60x60x86
- 4 gas burners with FFD, adjustable to natural gas
- Static upper cavity and bottom cavity with turbo function
- 24 hour programmable digital timer
- 1 triple wok burner
- 2 cavities with same time function
- Locked gas switches and knobs
- Automatic ignition from the knobs
- Grill function
- Oven inner lamp
- Thermostat controls enables to cook at desired heat
- Effective cooking with equal heat circulation
- Elegant inox design and protective glass lid
- 2 trays and 1 grill tray
- Utility drawer
- 58 lt bottom cavity, 27 lt upper cavity
- A class energy



13200 WMZS

- 7 functions
- White 60x60x86
- 3 gas + 1 electric burners with FFD, adjustable to natural gas
- Mechanical timer
- Locked gas switches and knobs
- Automatic ignition from the knobs
- Grill function
- Oven inner lamp
- Thermostat controls enables to cook at desired heat
- Effective cooking with equal heat circulation
- Protective glass lid
- 2 trays and 1 grill tray
- Utility drawer
- 58 lt inner cavity
- A class energy



13200 WDZS

- 7 functions
- White 60x60x86
- 3 gas + 1 electric burners with FFD, adjustable to natural gas
- 24 hour programmable digital timer
- Locked gas switches and knobs
- Automatic ignition from the knobs
- Grill function
- Oven inner lamp
- Thermostat controls enables to cook at desired heat
- Effective cooking with equal heat circulation
- Protective glass lid
- 2 trays and 1 grill tray
- Utility drawer
- 58 lt inner cavity
- A class energy



13200 IX DZS

- 7 functions
- Inox 60x60x86
- 3 gas + 1 electric burners with FFD, adjustable to natural gas
- 24 hour programmable digital timer
- Locked gas switches and knobs
- Automatic ignition from the knobs
- Grill function
- Oven inner lamp
- Thermostat controls enables to cook at desired heat
- Effective cooking with equal heat circulation
- Elegant inox design and protective glass lid
- 2 trays and 1 grill tray
- Utility drawer
- 58 lt inner cavity
- A class energy



13220 WMZS

- 7 functions
- White 60x60x86
- 3 gas + 1 electric burners with FFD, adjustable to natural gas
- Static upper cavity and bottom cavity with turbo function
- Mechanical timer
- Locked gas switches and knobs
- Automatic ignition from the knobs
- Grill function
- Oven inner lamp
- Thermostat controls enables to cook at desired heat
- Effective cooking with equal heat circulation
- Protective glass lid
- 2 trays and 1 grill tray
- Utility drawer
- 58 lt inner cavity
- A class energy



13220 WDZS

- 7 functions
- White 60x60x86
- 3 gas + 1 electric burners with FFD, adjustable to natural gas
- Static upper cavity and bottom cavity with turbo function
- 24 hour programmable digital timer
- Locked gas switches and knobs
- Automatic ignition from the knobs
- Grill function
- Oven inner lamp
- Thermostat controls enables to cook at desired heat
- Effective cooking with equal heat circulation
- Protective glass lid
- 2 trays and 1 grill tray
- Utility drawer
- 58 lt inner cavity
- A class energy



13220 IX DZS

- 7 functions
- Inox 60x60x86
- 3 gas + 1 electric burners with FFD, adjustable to natural gas
- Static upper cavity and bottom cavity with turbo function
- 24 hour programmable digital timer
- Locked gas switches and knobs
- Automatic ignition from the knobs
- Grill function
- Oven inner lamp
- Thermostat controls enables to cook at desired heat
- Effective cooking with equal heat circulation
- Elegant inox design and protective glass lid
- 2 trays and 1 grill tray
- Utility drawer
- 58 lt inner cavity
- A class energy



13100 HF DZS

- 7 functions
- Inox/glass 60x60x86
- 60 cm free standing black oven- 4 gas burners over electric oven
- Touch control digital timer
- Automatic ignition from knobs
- Cast iron pan supports
- Grill function
- Oven inner lamp
- Thermostat controls enables to cook at desired heat
- Effective cooking with equal heat circulation
- Utility drawer
- 58L inner cavity
- A class energy



13110 HF DZS

- 7 functions
- Inox/glass 60x60x86
- 60 cm free standing black oven- 4 gas burners over electric oven
- Static upper cavity and bottom cavity with turbo function
- Touch control digital timer
- Automatic ignition from knobs
- Cast iron pan supports
- Grill function
- Oven inner lamp
- Thermostat controls enables to cook at desired heat
- Effective cooking with equal heat circulation
- Utility drawer
- 58L inner cavity
- A class energy



table top hobs





17011 WWL - D/L

- 60 cm, enamel cooktop with 4 gas burners
- Side mounted control knobs - FFD
- Auto ignition system
- Enameled pan supports
- 1 strong burner: 3000W
- 2 normal burners: 1750W
- 1 economic burner: 1000W



17012 WWL - D/L

- 60 cm, enamel cooktop with 4 gas burners
- Side mounted control knobs - FFD
- Auto ignition system
- Enameled pan supports
- 1 strong burner: 3000W
- 2 normal burners: 1750W
- 1 economic burner: 1000W



17013 WWL - D/L

- 60 cm, enamel cooktop with, 1 electric and 3 gas burners
- Side mounted control knobs-FFD
- Auto ignitions system
- Enameled pan system
- 1 strong burner: 3000 W
- 1 normal burner: 1750 W
- 1 economic burner: 1000 W
- 1 electric hot plate: 1000W



17031 XXL - D/L

- 60 cm, stainless steel cooktop with 4 gas burners
- Side mounted control knobs - FFD
- Auto ignition system
- Enameled pan supports
- 1 strong burner: 3000W
- 2 normal burners: 1750W
- 1 economic burner: 1000W



17041 XXL - D/L

- 60 cm, stainless steel cooktop with 1 electric and 3 gas burners
- Side mounted control knobs - FFD
- Auto ignition system
- Enameled pan supports
- 1 strong burner: 3000W
- 1 normal burners: 1750W
- 1 economic burner: 1000W
- 1 electric hot plate: 1000W

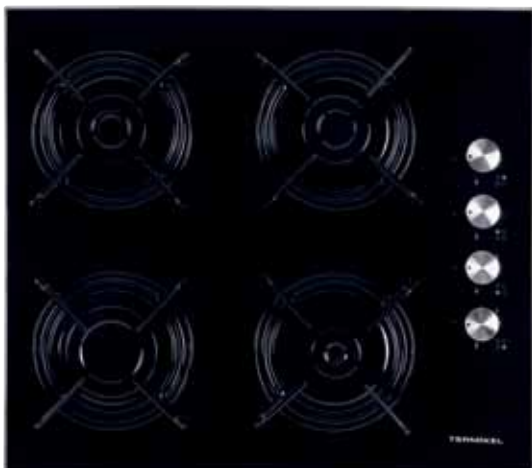

17062 GE - D/L

- 60 cm cooktop with 4 gas burners and glass surface
- Side mounted control knobs - FFD
- Auto ignition system
- Enameled pan supports
- 1 strong burner: 3000W
- 2 normal burners: 1750W
- 1 economic burner: 1000W

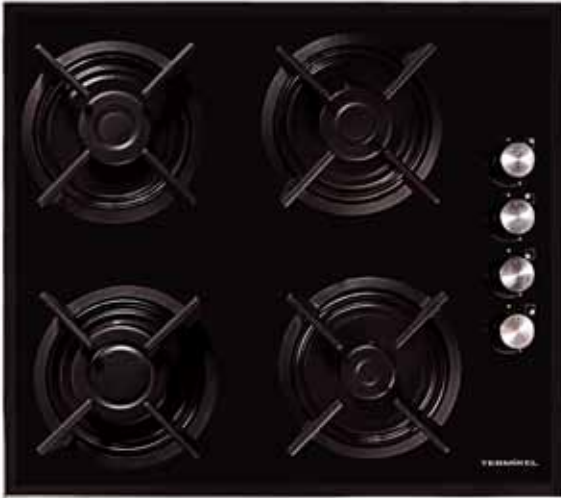

17162 GE - D/L

- 60 cm cooktop with 4 gas burners and glass surface
- Side mounted control knobs - FFD
- Auto ignition system
- Enameled pan supports
- 1 strong burner: 3000W
- 2 normal burners: 1750W
- 1 economic burner: 1000W



17262 GE - D/L

- 60 cm cooktop with 4 gas burners and glass surface
- Side mounted control knobs - FFD
- Auto ignition system
- Enameled pan supports
- 1 strong burner: 3000W
- 2 normal burners: 1750W
- 1 economic burner: 1000W

midi ovens





13006 WWB

- Oven body coated with electrostatic powder
- 3 different cooking functions
- Glass oven door, opening in two levels
- Enamel inner cavity and front panel
- 90/280 C thermostat
- 35 lt inner cavity
- Push in push out knobs
- Power: 1300 W
- Grill Power: 1200 W
- 54x47x32,5 cm (WxDxH)



13007 WWK

- Oven body coated with electrostatic powder
- 3 different cooking functions
- Glass oven door, opening in two levels
- 90 minutes mechanical timer
- Enamel inner cavity and front panel
- 90/280 C thermostat
- 35 lt inner cavity
- Power: 1300 W
- Grill Power: 1200 W
- 54x47x32,5 cm (WxDxH)



13007 WWB

- Oven body coated with electrostatic powder
- 3 different cooking functions
- Glass oven door, opening in two levels
- 90 minutes mechanical timer
- Push in push out knobs
- Enamel inner cavity and front panel
- 90/280 C thermostat
- 35 lt inner cavity
- Power: 1300 W
- Grill Power: 1200 W
- 54x47x32,5 cm (WxDxH)



13007 WWBT

- Oven body coated with electrostatic powder
- 3 different cooking functions plus turbo function
- Glass oven door, opening in two levels
- 90 minutes mechanical timer
- Push in push out knobs
- Enamel inner cavity and front panel
- 90/280 C thermostat
- 35 lt inner cavity
- Power: 1300 W
- Grill Power: 1200 W
- 54x47x32,5 cm (WxDxH)



13007 BIBIB

- Oven body coated with electrostatic powder
- 3 different cooking functions
- Glass oven door, opening in two levels
- 90 minutes mechanical timer
- Push in push out knobs
- Enamel inner cavity and black front panel
- 90/280 C thermostat
- 35 lt inner cavity
- Power: 1300 W
- Grill Power: 1200 W
- 54x47x32,5 cm (WxDxH)



13007 XBLK

- Oven body coated with electrostatic powder
- 3 different cooking functions
- Glass oven door, opening in two levels
- 90 minutes mechanical timer
- Enamel inner cavity and stainless steel front panel
- 90/280 C thermostat
- 35 lt inner cavity
- Power: 1300 W
- Grill Power: 1200 W
- 54x47x32,5 cm (WxDxH)



13007 XBLB

- Oven body coated with electrostatic powder
- 3 different cooking functions
- Glass oven door, opening in two levels
- 90 minutes mechanical timer
- Push in push out knobs
- Enamel inner cavity and stainless steel front panel
- 90/280 C thermostat
- 35 lt inner cavity
- Power: 1300 W
- Grill Power: 1200 W
- 54x47x32,5 cm (WxDxH)



13007 XBLBT

- Oven body coated with electrostatic powder
- 3 different cooking functions plus turbo function
- Glass oven door, opening in two levels
- 90 minutes mechanical timer
- Push in push out knobs
- Enamel inner cavity and stainless steel front panel
- 90/280 C thermostat
- 35 lt inner cavity
- Power: 1300 W
- Grill Power: 1200 W
- 54x47x32,5 cm (WxDxH)



13008 WWK

- Oven body coated with electrostatic powder
- 3 different cooking functions
- Rotisserie function
- Glass oven door, opening in two levels
- 90 minutes mechanical timer
- Enamel inner cavity and front panel
- 90/280 C thermostat
- 35 lt inner cavity
- Power: 1400 W
- Grill Power: 1200 W
- 54x47x32,5 cm (WxDxH)



13008 WWB

- Oven body coated with electrostatic powder
- 3 different cooking functions
- Rotiesserie function
- Glass oven door, opening in two levels
- 90 minutes mechanical timer
- Push in push out knobs
- Enamel inner cavity and front panel
- 90/280 C thermostat
- 35 lt inner cavity
- Power: 1400 W
- Grill Power: 1200 W
- 54x47x32,5 cm (WxDxH)



13008 BIBB

- Oven body coated with electrostatic powder
- 3 different cooking functions
- Rotiesserie function
- Glass oven door, opening in two levels
- 90 minutes mechanical timer
- Push in push out knobs
- Enamel inner cavity and front panel
- 90/280 C thermostat
- 35 lt inner cavity
- Power: 1400 W
- Grill Power: 1200 W
- 54x47x32,5 cm (WxDxH)



aspirators





16011 PBÇF

- 3 different speed settings
- Push button control system
- White outer surface easy to clean
- White front panel
- Halogen bulb 1x25 W
- 120 mm dia ducting kit
- 460 m³/h air flow capacity
- Noise level at step 1: 53 db (A)
- Electric power: 215 W



16011 PGÇF

- 3 different speed settings
- Push button control system
- White / Grey outer surface easy to clean
- Grey front panel
- Halogen bulb 1x25 W
- 120 mm dia ducting kit
- 460 m³/h air flow capacity
- Noise level at step 1: 53 db (A)
- Electric power: 215 W

washing machines





6224 GSV

- Digital program status indicator with LED
- Capacity: 12 servings
- Washing temperature: 40-65 C
- 6 Programmed: 3 in 1 Program, Intensive program, Normal program, Eco program, Pre-Washing, Short program
- Complete stainless steel inner body
- Salt and rinse aid indicator with LED
- Height adjustable upper basket
- 2 Spraying section, 2 spraying arms
- Gray dish baskets
- 1 dish basket, 2 lower basket with collapsible rack system
- 2 upper basket with cup rack equipment, Height adjustable upper basket
- Rear legs adjustable from the front
- Mechanical safety system
- Multiple water protection
- Resistance protection system
- Heater, Stainless steel filter
- Water leash safety system

Important data and dimensions

- Energy efficiency class A+
- Cleaning effect A
- Drying effect A
- Energy consumption: 1.02 kWh
- Energy consumption: 291 kWh
- Water consumption: 12 L /year
- Water consumption: 3360 L/year
- Water Connection : max.60C
- Low noise level: 49dB (A)
- Input power: 1.93 kW
- Product measures (HxWxD): 820x595x540 mm
- Installation measures (HxWxD): 820x600x570 mm



6214 GSI

- Digital program status indicator with LED
- Capacity: 12 servings
- Washing temperature: 40-65 C
- 6 Programmed: 3 in 1 Program, Intensive program, Normal program, Eco program, Pre-Washing, Short program
- Complete stainless steel inner body
- Salt and rinse aid indicator with LED
- Height adjustable upper basket
- 2 Spraying section, 2 spraying arms
- Gray dish baskets
- 1 dish basket, 2 lower basket with collapsible rack system
- 2 upper basket with cup rack equipment, Height adjustable upper basket
- Rear legs adjustable from the front
- Mechanical safety system
- Multiple water protection
- Resistance protection system
- Heater, Stainless steel filter
- Water leash safety system

Important data and dimensions

- Energy efficiency class A+
- Cleaning effect A
- Drying effect A
- Energy consumption: 1.05 kWh
- Energy consumption: 320 kWh
- Water consumption: 16 L / year
- Water consumption: 4620 L / year
- Water Connection : max. 60C
- Low noise level: 49dB (A)
- Input power: 1.93 kW
- Product measures (HxWxD): 820x595x540 mm
- Installation measures (HxWxD): 820x600x570 mm

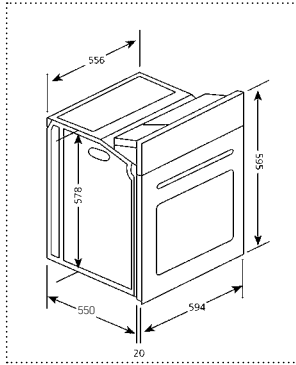

BUILT-IN OVENS

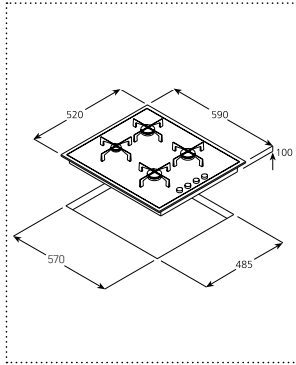

BUILT-IN HOBS

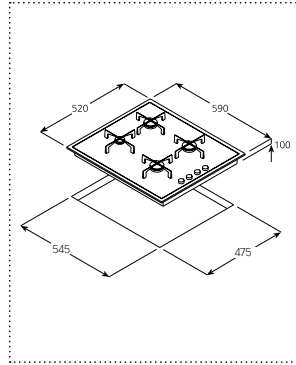

BUILT-IN HOBS

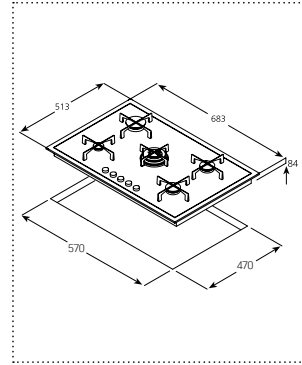

BUILT-IN HOBS

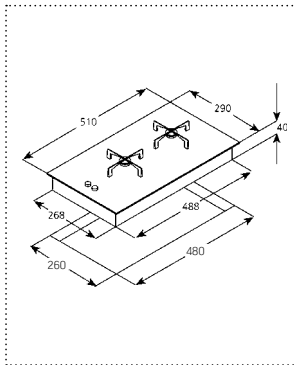

BUILT-IN HOBS

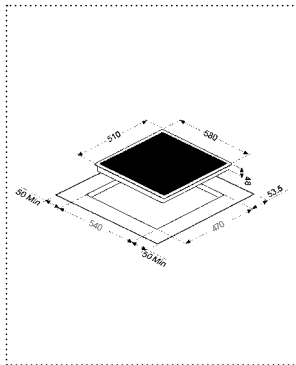

BUILT-IN HOBS

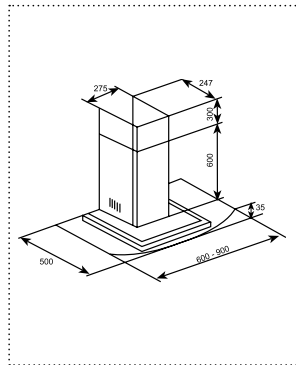

HOODS

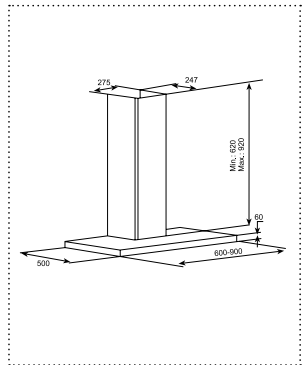

HOODS

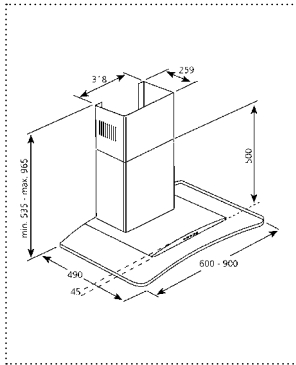

HOODS

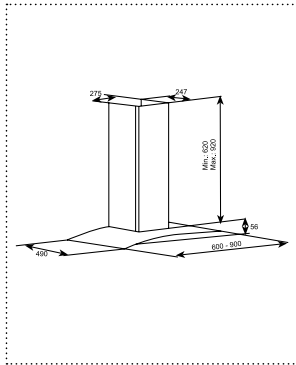

HOODS

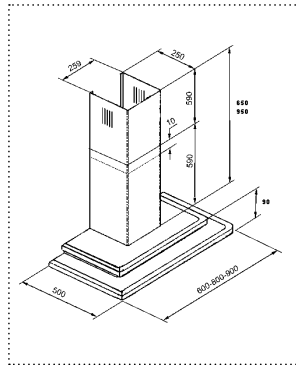

HOODS

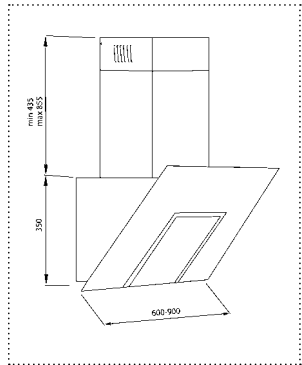

HOODS

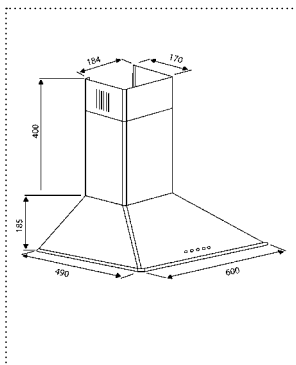

HOODS

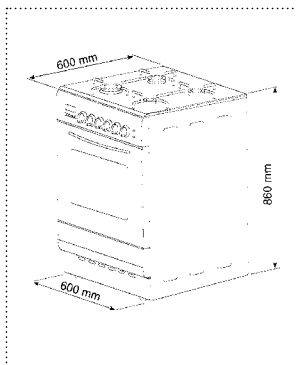

FREE STANDING COOKERS

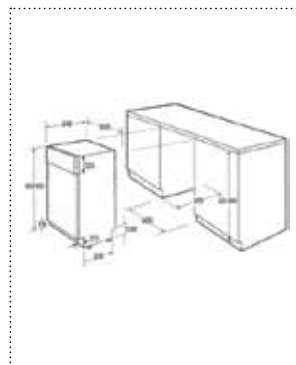

WASHING MACHINES

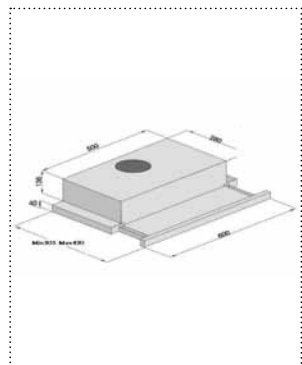

ASPIRATORS